



TECNISUN



*Fabricant français de capteurs solaires thermiques
à tubes sous vide*







TECNISUN - 38 800 Le Pont de Claix - www.tecnisun.com

Contact : Clément Mabire - c.mabire@tecnisun.com



Les écotecnologies : un levier de développement durable

Notre philosophie:

-  *Entreprendre et Créer de la valeur économique*
-  *Apporter une plus value sociale*
-  *Répondre aux enjeux actuels et ceux de demain*
-  *Développer une nouvelle culture citoyenne*



***42% de notre énergie totale est transformée
en chaleur produisant 22% de nos GES***

***Le solaire thermique: de l'autonomie énergétique à l'
opportunité industrielle***







Un Contexte Favorable pour les Energies Renouvelables

Les principes d'une réelle opportunité

-  ***Une production énergétique décentralisée***
-  ***Le développement de savoir-faire techniques, industriels***
-  ***La structuration de filières compétentes***

Les outils du développement

-  ***Loi POPE, Plan soleil***
-  ***Tarifs d'achat de l'électricité verte***
-  ***Crédit d'impôt***
-  ***Grenelle, fond chaleur, Eco PTZ***
-  ***RT 2012 et norme BBC***



Le marché français en chiffre

Une priorité donnée au secteur résidentiel en 2009



36 000 Chauffe Eau Solaires Individuels

2500 Systèmes Solaires Combiné

68 000 m² en Chauffe Eau Solaires Collectif

2009 < 265 000 m² installés = 185,5 Mwh Th



***+ 15% en 2007 , + 20% en 2008
Première croissance en Europe***



***2009: Solaire photovoltaïque : +224%
Solaire thermique: -15% (-14% CESI & -56% SSC)***

Objectif 2012= 1 000 000m²/an











Les marchés du solaire thermique: les entreprises Combien de consommateurs de chaleur ?

-  ***Agriculture & Industrie agroalimentaire***
 -  ***Tourisme & Restauration***
 -  ***Loisir et sports***
 -  ***Bâtiments, résidentiel, santé, militaire, éducatif***
 -  ***Nettoyage (process, auto,...) & maintenance***
 -  ***Industrie (textile, chimie,...) transport***
 -  ***Tertiaire: Chauffage & climatisation***
-  ***Taux de couverture solaire garanti de 30 à 80%***



TECNISUN

Objectif: répondre à un besoin en améliorant la performance économique de son entreprise

-  ***Coûts énergétiques croissants***
-  ***Réduire sa dépendance énergétique***
-  ***S'offrir de la visibilité sur les coûts d'exploitation***
-  ***Améliorer sa compétitivité à longs termes***
-  ***Bénéficier des aides en vigueur***
-  ***Ne pas alourdir son endettement***
-  ***Anticiper la réglementation***
-  ***Participer à l'effort collectif de réduction des GES***
-  ***Donner de la valeur à son entreprise et une nouvelle image***

Les processus de montage de projets en Quatuor

Utilisateur - BE - Installateur - Fournisseur

 ***Bénéfice fiscal 39 AB CGI***

 ***Aides Ademe régionale / plan état région***

 ***Fond chaleur***

	Zone Géographique	Aide en €/tep solaire utile produite annuellement	Productivité minimum solaire utile [kWh utile/m ² .an]	Ratio maximum sur montant d'Investissement [€/kWh utile]
Logement Collectif	Nord	12 500€/Tep	> 350	< 2,50
	Sud	12 000€/Tep	> 400	< 2,25
	Med	10 500€/Tep	> 450	< 2,00
Tertiaire, Industrie et Agriculture	Nord	10 500€/Tep	> 350	< 2,50
	Sud	10 000€/Tep	> 400	< 2,25
	Med	9 000€/Tep	> 450	< 2,00

**Production solaire indicative en MWh utile/an: 1 tep= 11,63 MWh*

Technologies et performances

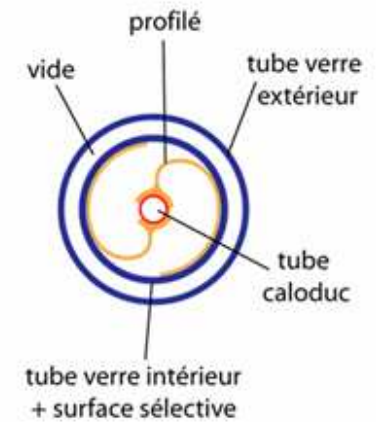
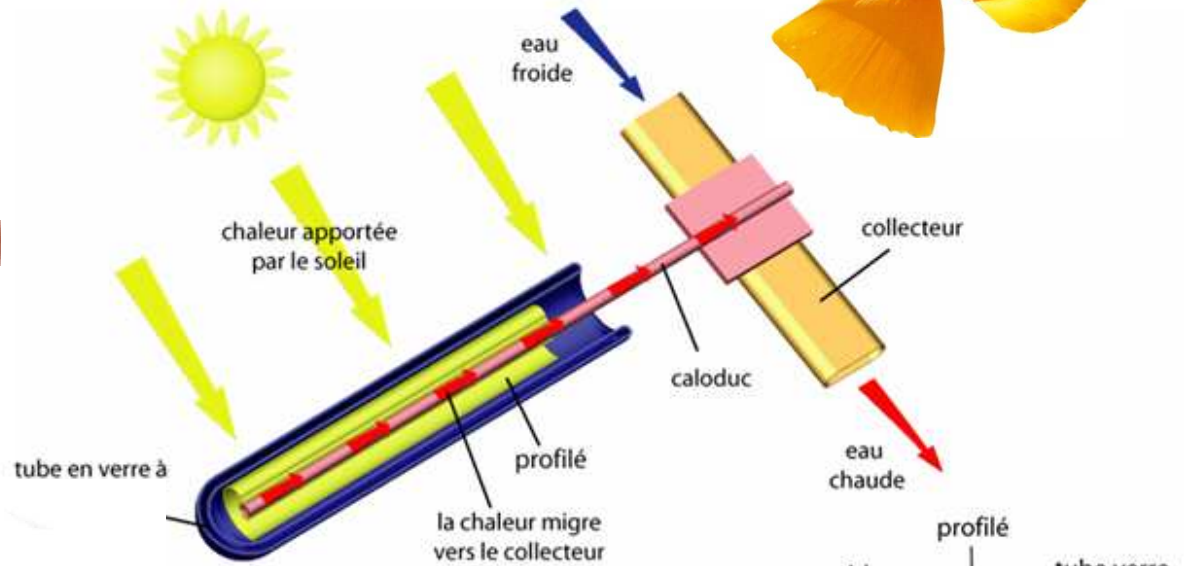
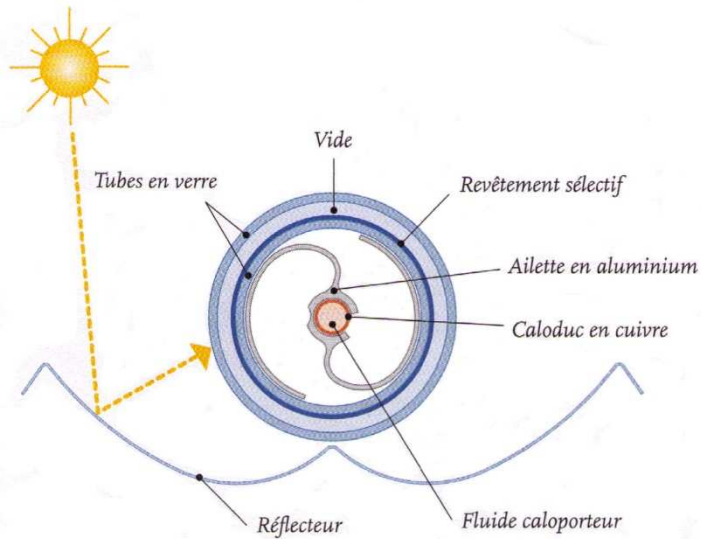

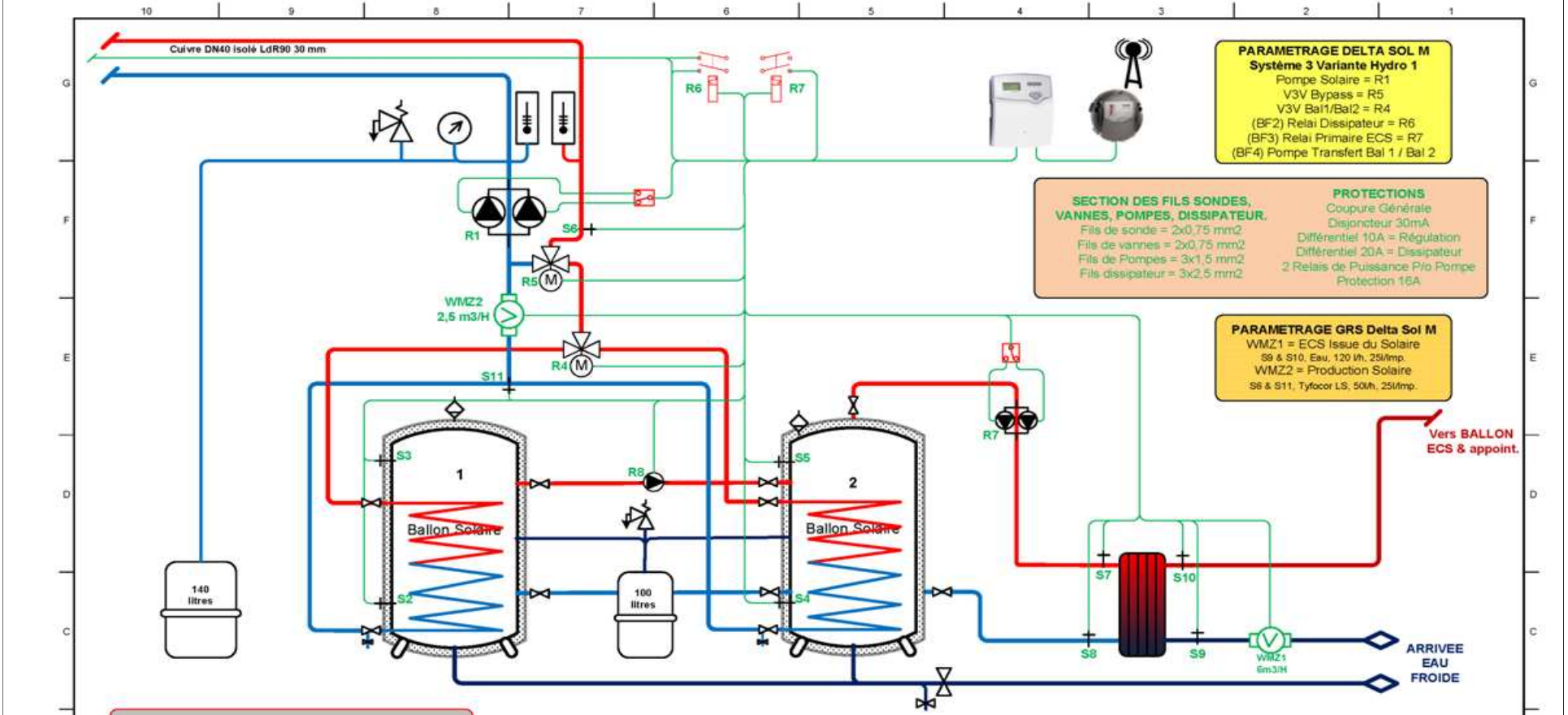



TECNISUN

**Fabrication française de capteurs solaires
thermiques à tubes sous vide
Concepteur de systèmes solaires thermiques**

TECNISUN - 38 800 Le Pont de Claix

www.tecnisun.com

Tel: 04.76.90.33.57 & Fax: 04.76.90.33.98

Contact : Clément Mabire - c.mabire@tecnisun.com